

Cultural Library-Sustainable Mobility

Mobility of loves-Blood donation

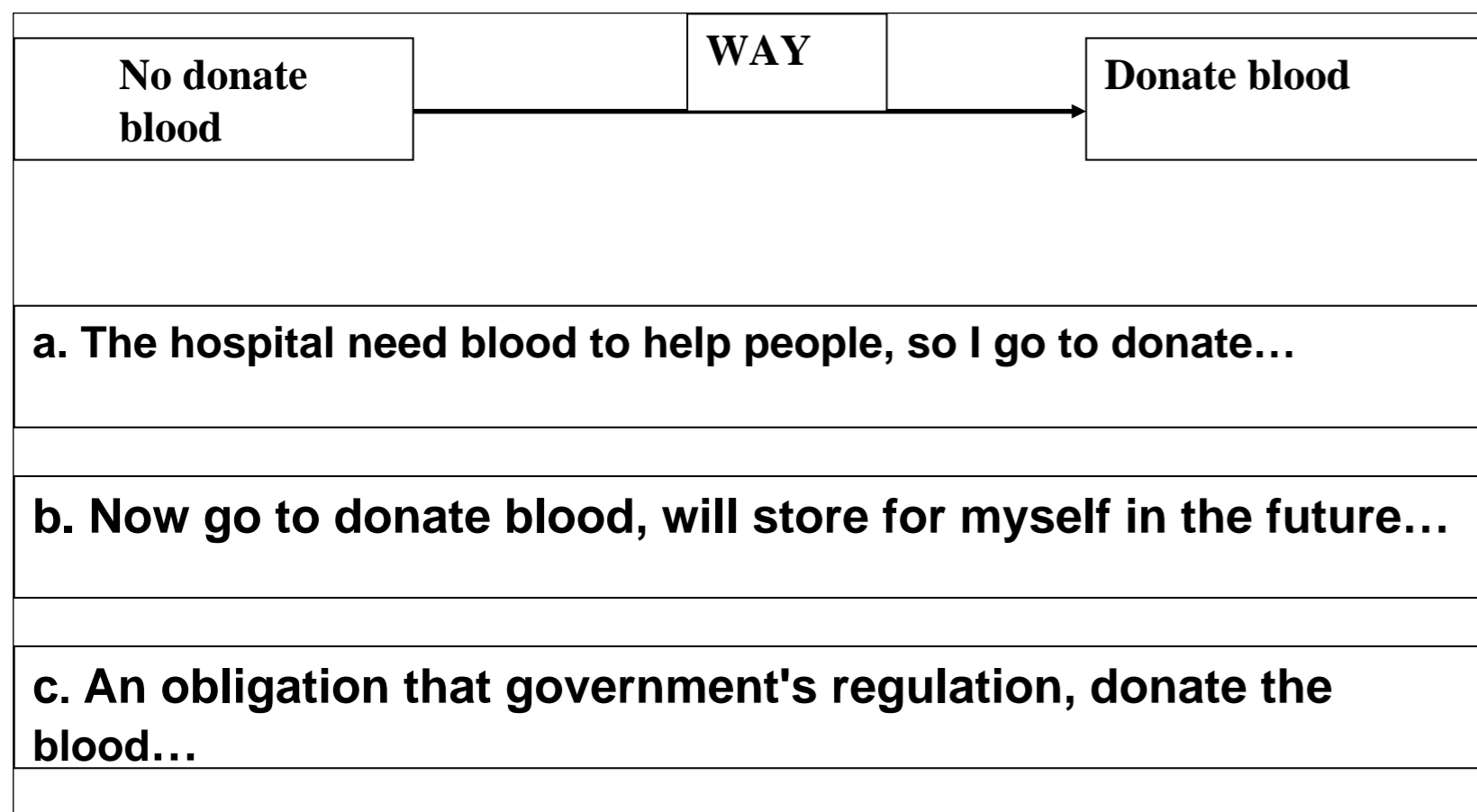
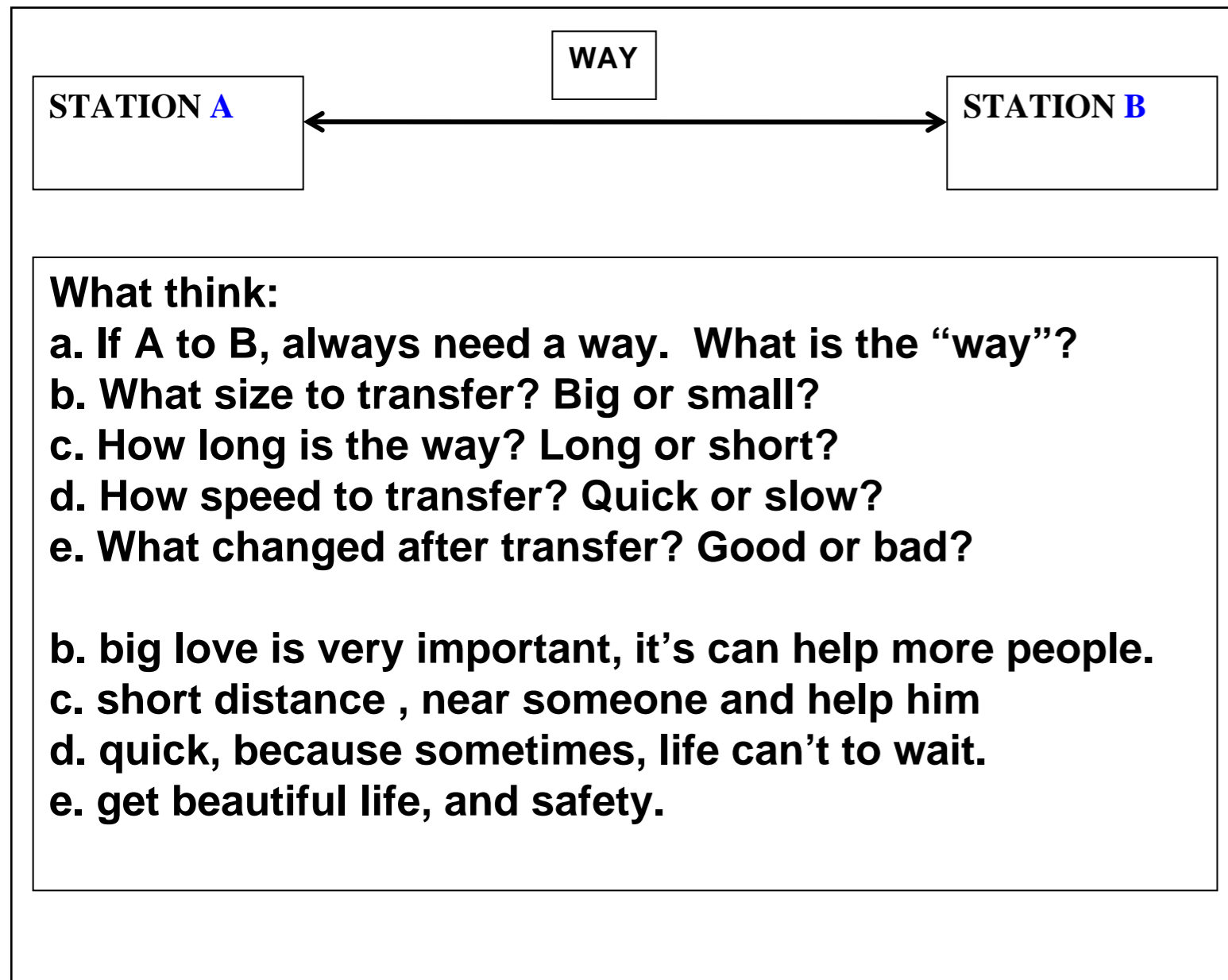

What needs finishing in advance?

- to teach → a few people will put in the heart
- needn't do anything → because it's a clever choice for most persons.
- many people to notice other people → many people is learnt to hide.
(hide: don't do more)

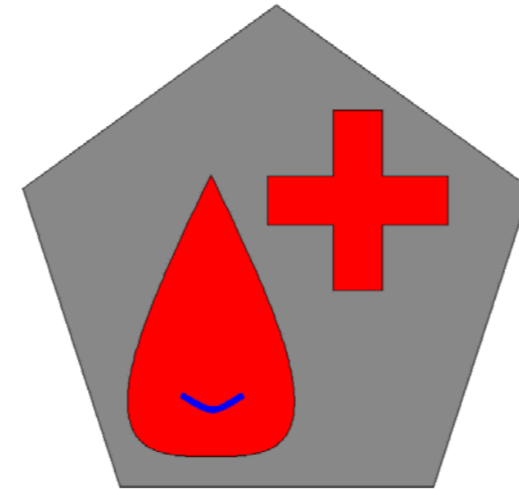
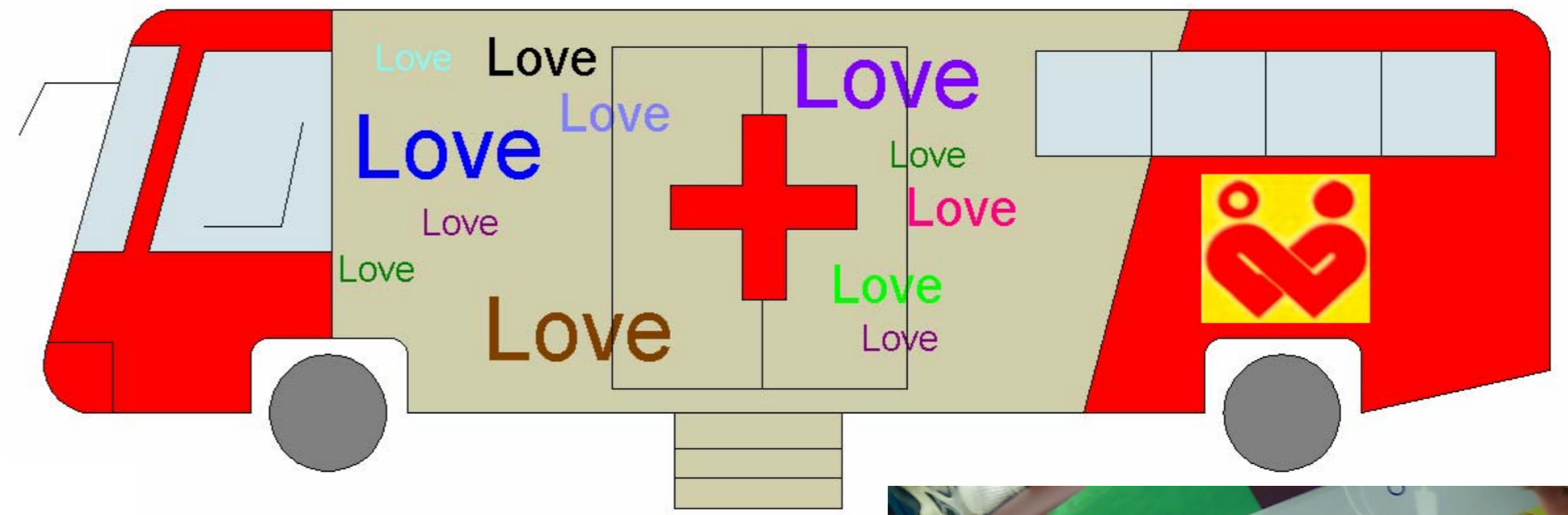

RATIONAL: THINK CLEVER

national health card

- When donate blood once, write down once.
- When he is in hospital, will get expensive service.
- When store many times, will discount his insurance cost.

EMOTIONAL: FEEL GOOD

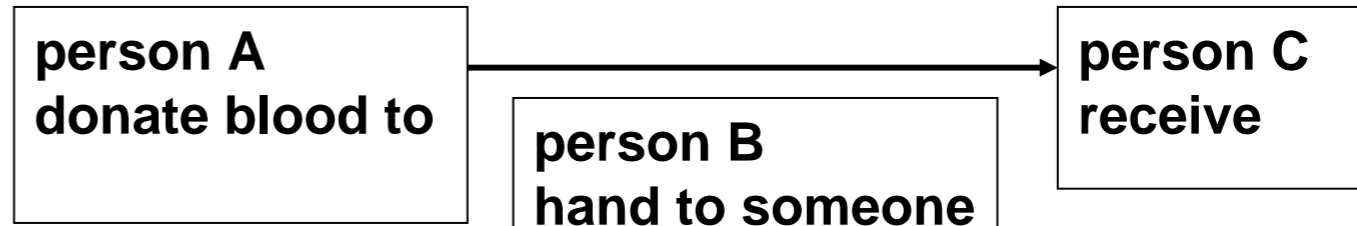

Person A's feeling:

- * give a label to show out (such as a tag, a pen, a master card)
- other people know who donate blood, maybe he need to do, too...
- other people like to make friend with me...
- * when used his blood, give he a message.(don't know who, where)
- Yes, I just help someone, and I like the feeling, and continue...
- * from TV, E-mail, hand bill....know donate blood is right

Person B's feeling:

- * to count the number, How many helps had done?
- * different uniform to the reputable nurse

Person C's feeling:

- *Let him know that how many people help him...
- I will also do it...

Cultural Library-Sustainable Mobility

Mobility of loves-Blood donation

NO DONATE BLOOD $\xrightarrow[\text{?}]{\text{WAY}}$ DONATE BLOOD

- a. The hospital need blood to help people, so I go to donate...
- b. Now go to donate blood, will store for myself in the future...
- c. An obligation that government's regulation, donate the blood...

**RATIONAL:
THINK CLEVER**

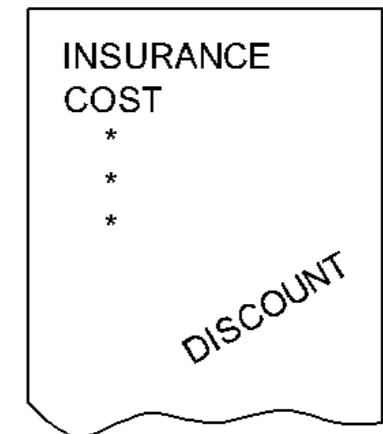
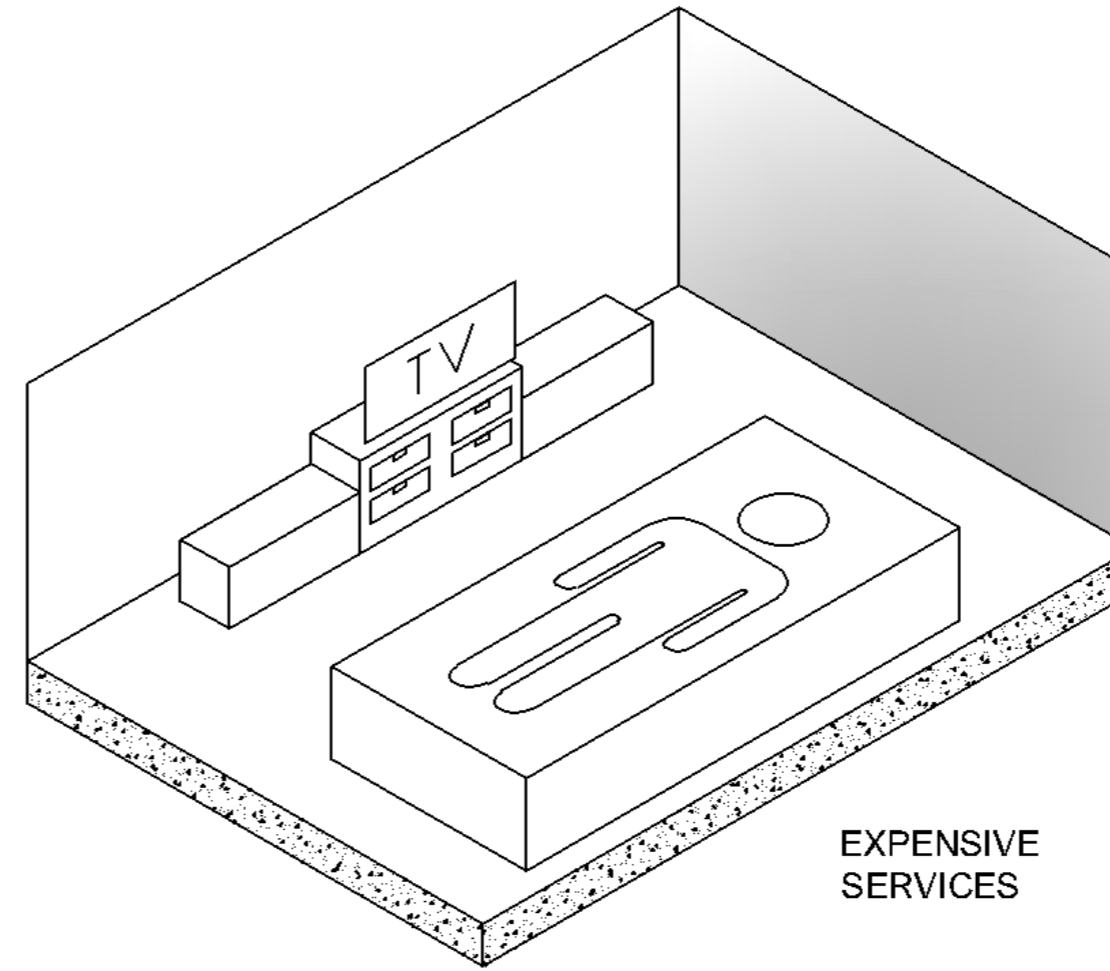
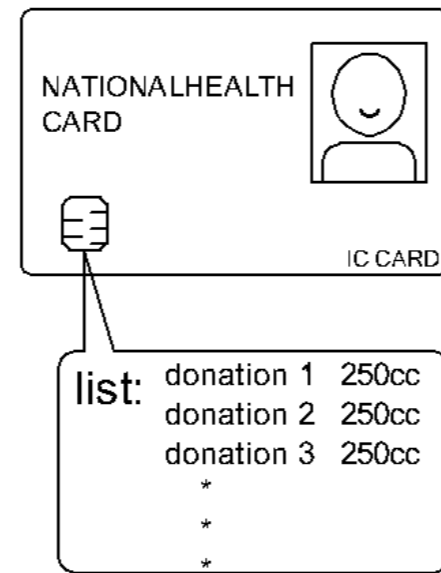
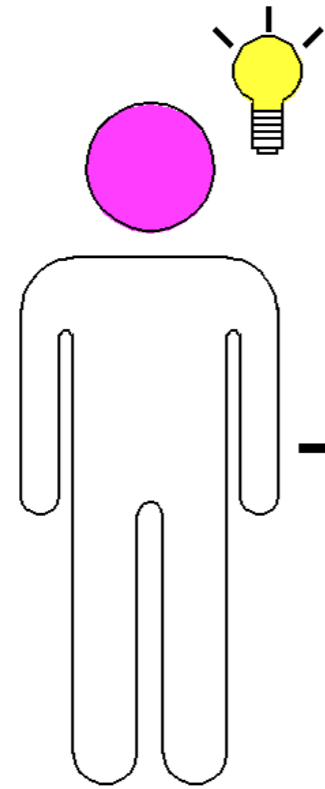

**EMOTIONAL:
FEEL GOOD**

